Chapter 10

Concrete Production Process

CONCRETE PRODUCTION PRACTICES

1. General	294
2. Batching of Materials	294
3. Mixing	295
3.1 Types of mixers	295
3.2 Uniformity of mixing	298
3.3 Mixing time	298
4. Handling, transporting, placing	298
5. Compacting	298
5.1 Internal vibrator	299
5.2 External vibrator	300
5.3 Vibrating table	300
5.4 Surface vibrator	300
6. Curing of concrete	300
6.1 Length of curing period	300
6.2 Curing methods	301
6.3 Curing Compounds	302
6.4 Steam curing	303
7. Hot weather concreting	304
8. Cold Weather Concreting	307
9. Ready-Mixed Concrete	309
10. Pumped Concrete	310
11. Special Concreting Processes	314
12. LITERATURE	315
12.1 Concrete Technology	315
12.2 Concrete practice	315
12.3 Testing of Concrete	315

1. GENERAL

Characteristics and properties of fresh and hardened concrete depend to a great extent upon mix design and quality of the constituent materials.

However, the importance of mixing, transporting, placing and curing techniques should not be neglected.

Improved production practices and techniques will then contribute considerably to achieving a good concrete. Each stage of concrete production is important and has an influence on the final concrete serviceability.

2. BATCHING OF MATERIALS

To produce concrete of uniform quality, the ingredients must be measured accurately for each batch. Most new specifications require that batching be done by weight rather than by volume because of the inaccuracies in measuring solid materials (especially damp sand) by volume. The weight system for batching provides greater accuracy, simplicity and flexibility. Flexibility is necessary because changes in the aggregate moisture content require frequent adjustments in batch quantities of water and aggregates. Water can be measured accurately by either volume or weight.

ACI specifications generally require that materials be measured within this percentage of accuracy:

cement	± 1%
aggregates	± 2%
water	± 1%
admixtures	± 3%

The ERMCO (European Ready Mixed Concrete Organisation) Code of good practice for Ready-Mixed Concrete gives recommendations for batching tolerance as listed in Table 1.

Table 1: Accuracy of batching acc. ERMCO

Material	Tolerance
Cement	± 3%
Coarse aggregate	± 3%
Fine aggregate	± 3%
Admixtures	± 5%
Water	± 3%

Equipment should be capable of measuring quantities within these tolerances for the smallest batch regularly used, as well as for larger batches.

The accuracy of batching equipment should be checked periodically and adjusted when necessary. Admixture dispensers should be checked daily since errors in admixture batching, particularly overdosing, can lead to serious problems in both fresh and hardened concrete.

3. MIXING

The objective of mixing is:

- ◆ to coat the surface of all aggregate particles with cement paste
- ◆ to blend all the ingredients of concrete into a uniform mass
- ◆ to maintain uniformity of concrete at the discharging from the mixer

All concrete should be mixed thoroughly until it is uniform in appearance, with all ingredients evenly distributed. Mixers should not be loaded above their rated capacities and should be operated at approximately the speeds for which they were designed. If the blades of the mixer become worn or coated with hardened concrete, the mixing action will be less efficient. Badly worn blades should be replaced and hardened concrete should be removed periodically, preferably after each day's run of concrete.

3.1 Types of mixers

The method of discharging is one of the criteria for the classification of concrete mixers.

Tilting Mixer: Mixing chamber (drum) is tilted for discharging (see Figure 1).

Figure 1: Tilting mixer

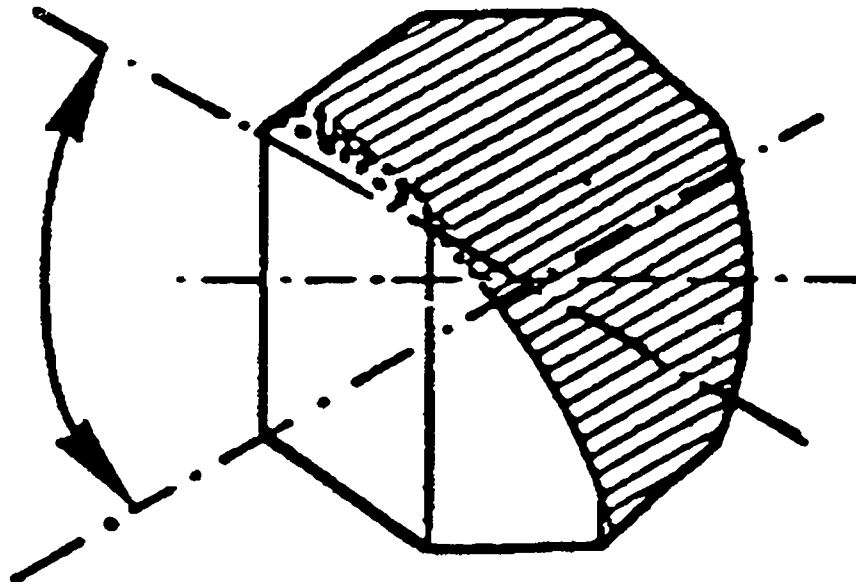

Drum (non-tilting) mixer: The axis of the mixer is always in a horizontal position, and discharge is effected by inserting a chute into the drum or by reversing the direction of rotation of the drum, as applied in the truck mixer used in the ready-mixed concrete production (see Figure 2).

Figure 2: Drum (non-tilting) mixer

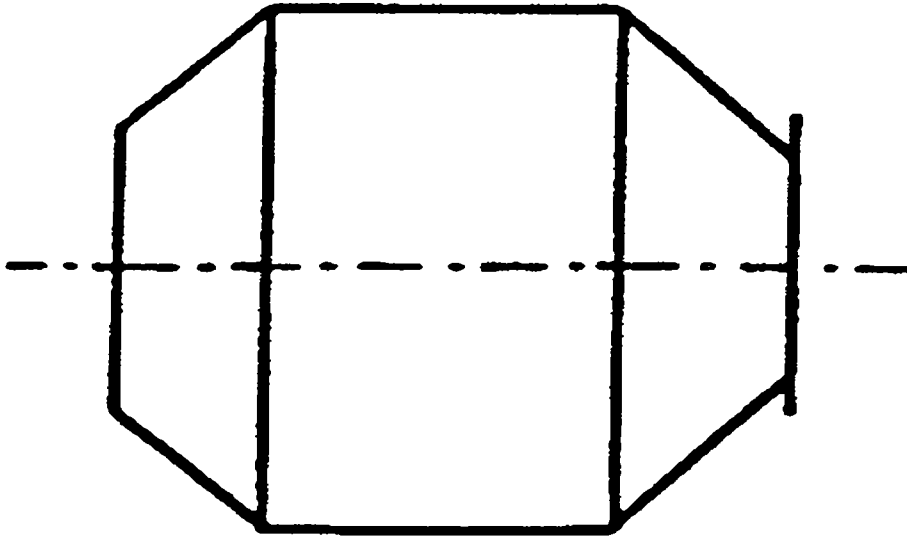

Pan mixer: consists of a circular pan rotating about its axis, with one or two stars of paddles rotating about a vertical axis not coincident with the axis of the pan (see Figure 3).

Figure 3: Pan mixer

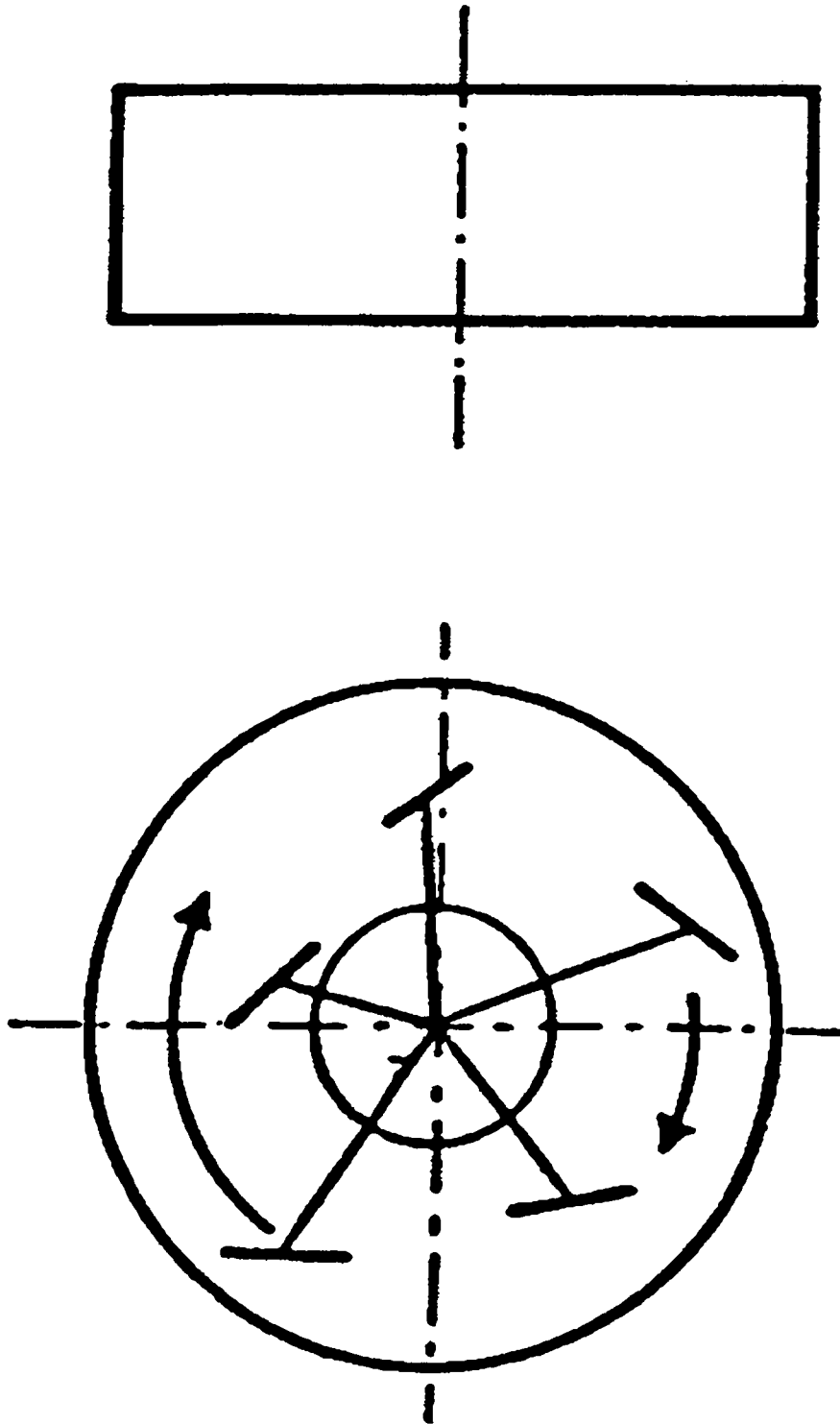

The capacity of tilting and drum mixers is usually large (up to 6 m³), whereas the pan mixer is smaller (up to 2 m³) and is particularly efficient for stiff and cohesive mixes often used in precast concrete industry.

Bowl-and-stirrer Mixer (cake mixer): works according to the same principle as the pan mixer and is sometimes used for mixing of mortar.

3.2 Uniformity of mixing

The efficiency of the mixer can be determined by the variability of the mix discharged into a number of samples without interrupting the flow of concrete.

The values given in Table 2 are the highest acceptable values for a 'satisfactory' mixer.

Table 2: Variability of concrete in a 'satisfactory' mixer

Compressive strength	4 - 6%
Percentage of coarse aggregate	6 - 8%
Percentage of fine aggregate or cement	5 - 8%

3.3 Mixing time

The mixing time varies with the type of mixer and, strictly speaking, it is not the mixing time but the number of revolutions of the mixer that is the criterion of adequate mixing. Generally about 50 revolutions are sufficient.

4. HANDLING, TRANSPORTING, PLACING

Each step in handling, transporting and placing concrete should be carefully controlled to maintain uniformity within the batch and from batch to batch so that the completed work is consistent throughout. It is essential to avoid separation of the coarse aggregate from the mortar or of water from the other ingredients.

Concrete is handled and transported by many methods. These include the use of chutes, buggies operated over runways, buckets handled by cranes or cabinways, small railroad cars, trucks, pumping through pipelines, and pneumatically forcing the concrete or dry concrete materials through hoses.

Preparation prior to placing includes compacting, trimming and moistening the subgrade; erecting the forms; and setting the reinforcing steel. A moist subgrade is especially important in hot weather to prevent extraction of water from the concrete.

Forms should be clean, tight, adequately braced, and constructed of materials that will impart the desired texture to the finished concrete. Sawdust, nails and other debris should be removed before concrete is placed. Wood forms should be moistened before placing concrete; otherwise they will absorb water from the concrete and swell. Forms also should be treated with a releasing agent such as oil or lacquer to facilitate their removal. For architectural concrete, lacquer or emulsified stearates are used since they are non-staining.

Reinforcing steel should be clean and free of loose rust or mill scale at the time concrete is placed. Any coatings of hardened mortar should be removed from the steel.

5. COMPACTING

The process of compacting concrete consists essentially of the elimination of air voids.

The oldest means of achieving this is by ramming or punning the surface of concrete. The most common method for compacting is by vibration. The use of vibration makes it possible to work with drier mixes, so that concrete with a lower water/cement ratio and a lower cement content can be manufactured. Whether or not vibrators can be employed is determined by the consistency of the mix. Mixes which are very wet should not be vibrated as separation may result. Each type of vibrator requires a different consistency.

Various types of vibrators have been developed (see also Figure 4):

Figure 4: Various types of vibrators

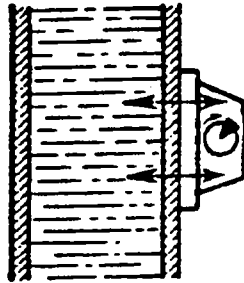

External vibrator

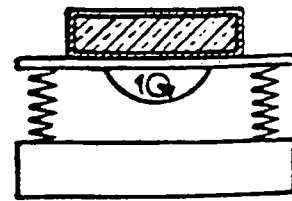

Vibrating table

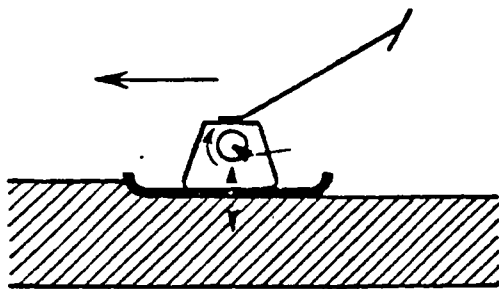

Surface vibrator

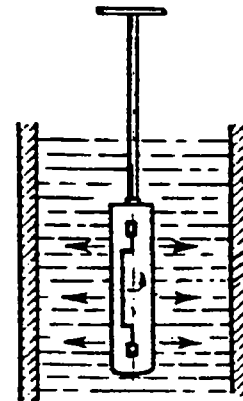

Internal vibrator

5.1 Internal vibrator

Of the several types of vibrators this is perhaps the most common one. It consists essentially of a poker, housing an eccentric shaft driven through a flexible drive from a motor. The poker is immersed in concrete and thus applies approximately harmonic forces to it; hence, the alternative names of poker- or immersion vibrator.

The frequency of vibration varies up to 12'000 cycles of vibration per minute.

The poker is easily moved from place to place, and is applied at 50 to 70 cm centers for 5 to 30 sec., depending on the consistency of the mix.

5.2 External vibrator

This type of vibrator is rigidly clamped to the formwork resting on an elastic support, so that both the form and the concrete are vibrated. As a result, a considerable proportion of the work done is used in vibrating the formwork, which also has to be strong and tight so as to prevent distortion and leakage of grout.

The principle of an external vibrator is the same as that of an internal one, but the frequency is usually between 3000 and 6000 cycles.

5.3 Vibrating table

This can be considered as a case of formwork clamped to the vibrator instead of the other way round, but the principle of vibrating the concrete and formwork together is unaltered.

The source of vibration, too, is similar. Generally a rapidly rotating eccentric weight makes the table vibrate with a circular motion. With two shafts rotating in opposite directions the horizontal component of vibration can be neutralized so that the table is subjected to a simple harmonic motion in the vertical direction only.

5.4 Surface vibrator

A surface vibrator applies vibration through a flat plate direct to the top surface of the concrete. In this manner the concrete is restrained in all directions so that the tendency to segregate is limited; for this reason a more intense vibration can be used.

6. CURING OF CONCRETE

Properties of concrete such as resistance to freezing and thawing, strength, watertightness, wear resistance, and volume stability improve with age as long as conditions are favorable for continued hydration of the cement. The improvement is rapid at early ages but continues more slowly for an indefinite period. Two conditions for such improvement in quality are required:

- ◆ the presence of moisture
- ◆ a favorable temperature

Excessive evaporation of water from newly placed concrete can significantly retard the cement hydration process at an early age. Loss of water also causes concrete to shrink, thus creating tensile stresses at the drying surface. If these stresses develop before the concrete has attained adequate strength, surface cracking may result. All exposed surfaces, including exposed edges and joints, must be protected against moisture evaporation.

Hydration proceeds at a much slower rate when the concrete temperature is low; from a practical standpoint there is little chemical action between cement and water when the concrete temperature is near or below freezing. It follows that concrete should be protected so that moisture is not lost during the early hardening period and the concrete temperature is kept favorable for hydration.

6.1 Length of curing period

Since all the desirable properties of concrete are improved by curing, the curing period should be as long as practicable in all cases.

The length of time that concrete should be protected against loss of moisture is dependent upon the type of cement, mix proportions, required strength, size and shape of the concrete mass, weather and future exposure conditions. This period may be a month or longer for lean concrete mixtures used in structures such as dams; conversely, it may be only a few

days for richer mixes, especially if Type III of high-early-strength cement is used. Steam-curing periods are normally much shorter.

For most structural uses, the curing period for cast-in-place concrete is usually 3 days to 2 weeks, depending on such conditions as temperature, cement type, mix proportions, etc. More extended curing periods are desirable for bridge decks and other slabs exposed to weather and chemical attack.

6.2 Curing methods

There are different methods to cure concrete:

- 1) Methods that supply additional moisture to the surface of the concrete during the early hardening period. These include sprinkling and using wet coverings. Such methods afford some cooling through evaporation, which is beneficial in hot weather.
- 2) Methods that prevent loss of moisture from the concrete by sealing the surface. This may be done by means of waterproof paper, plastic sheets, liquid membrane-forming compounds, and forms left in place.
- 3) Methods that accelerate strength gain by supplying heat and moisture to the concrete. This is usually accomplished with live steam or heating coils.

Sprinkling (see Figure 5)

Continuous sprinkling with water is an excellent method of curing. If sprinkling is done at intervals, care must be taken to prevent the concrete from drying between application of water. A disadvantage of sprinkling may be its cost. The method requires an adequate supply of water and careful supervision.

Figure 5: Sprinkling

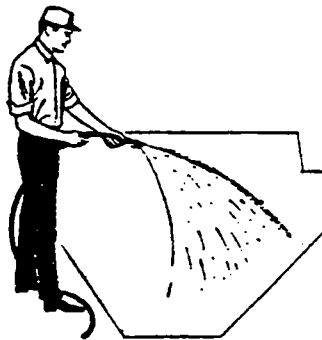

Wet coverings

Burlap, cotton mats, or other moisture-retaining fabrics are used for curing. Treated burlaps that reflect light and are resistant to rot and fire are available. Coverings should be placed as soon as the concrete has hardened sufficiently to prevent surface damage. Care should be taken to cover the entire surface, including the edges of slabs such as pavements and sidewalks. The coverings should be kept continuously moist so that a film of water remains on the concrete surface throughout the curing period.

Waterproof paper (see Figure 6)

Waterproof curing paper is an efficient means of curing horizontal surfaces and structural concrete of relatively simple shapes. One important advantage of this method is that periodic additions of water are not required.

Figure 6: Waterproof paper

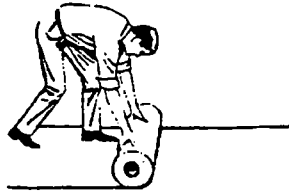

Plastic sheets (see Figure 7)

Certain plastic sheet materials (polyethylene films) are used to cure concrete. They are lightweight, effective moisture barriers and easily applied to simple as well as complex shapes.

In some cases, the use of thin plastic sheets for curing may discolor the hardened concrete. This may be especially true when the concrete surface has been steel-troweled to a hard finish. When such discoloration is objectionable, some other curing method is advisable.

Figure 7: Plastic sheets

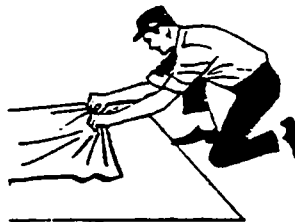

6.3 Curing Compounds

Liquid membrane-forming curing compounds retard or prevent evaporation of moisture from the concrete. They are suitable not only for curing fresh concrete, but also for further curing of concrete after removal of forms or after initial moist curing.

The concrete surface should be moist when the coating is applied. Normally only one smooth, even coat is applied, but two coats may be necessary to ensure complete coverage. A second coat, when used, should be applied at right angles to the first.

Curing compounds used in hot weather should be white colored.

Curing compounds are applied by hand-operated or power-driven spray equipment (see Figure 8) immediately after the disappearance of the water sheen and the final finishing of the concrete.

Figure 8: Curing compounds

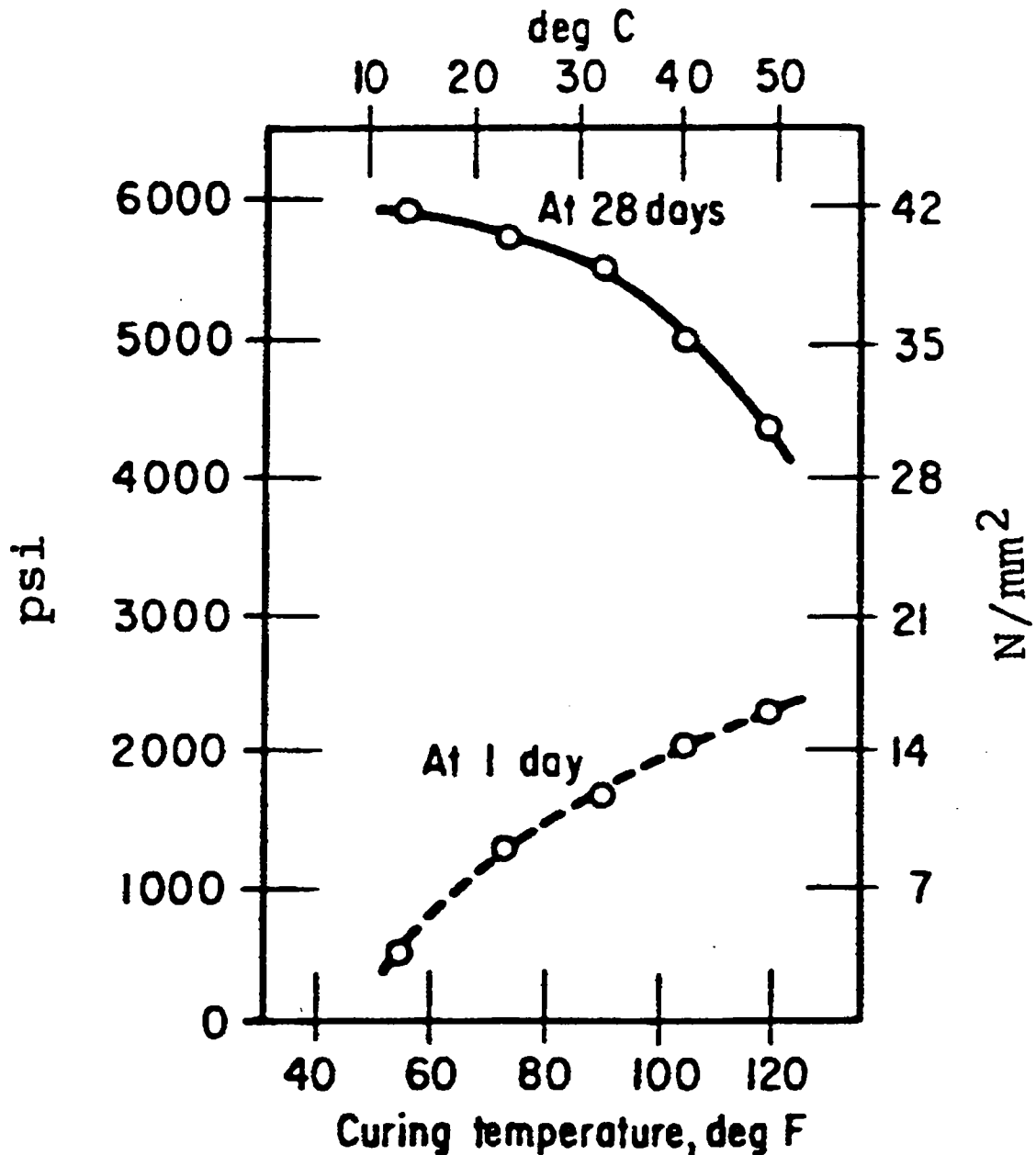

6.4 Steam curing

Of the methods in Group 3, accelerating the strength development, the most common is steam curing. It can be used to advantage where early strength gain in concrete is important or where additional heat is required to accomplish hydration, as in cold-weather concreting.

Two methods of steam curing for early strength gain are used today:

- ◆ curing in live steam and atmospheric pressure (for enclosed cast-in-place structures and manufactured precast concrete units)
- ◆ curing in high-pressure steam autoclaves (for small manufactured units).

A steam-curing cycle consists of:

- 1) an initial delay prior to steaming
- 2) a period for increasing temperature
- 3) a period for holding the maximum temperature constant
- 4) a period for decreasing temperature

A typical atmospheric steam-curing cycle is shown in Fig. 11, chapter 'Concrete Categories', paragraph 3.6.

Steam curing at atmospheric pressure is generally done in a steam chamber or other enclosure to minimize moisture and heat losses.

High-pressure steam curing in autoclaves takes advantage of temperatures in the range of 160 to 190°C and corresponding pressures. Hydration is greatly accelerated and the elevated temperatures and pressures may produce additional beneficial chemical reactions between the aggregates and/or cementitious materials that do not occur under normal steam curing.

7. HOT WEATHER CONCRETING

Hot weather for concreting is defined as any combination of high air temperature, low relative humidity and wind velocity, tending to impair the quality of fresh or hardened concrete or otherwise resulting in abnormal properties. Hot weather can adversely affect the properties and serviceability of concrete.

Concrete mixed, placed and cured at elevated temperatures normally develops higher early strength than concrete produced at normal temperatures, but the 28 day or later strength is generally lower (Figure 9).

Figure 9: Influence of curing temperatures on strength at day and 28 days

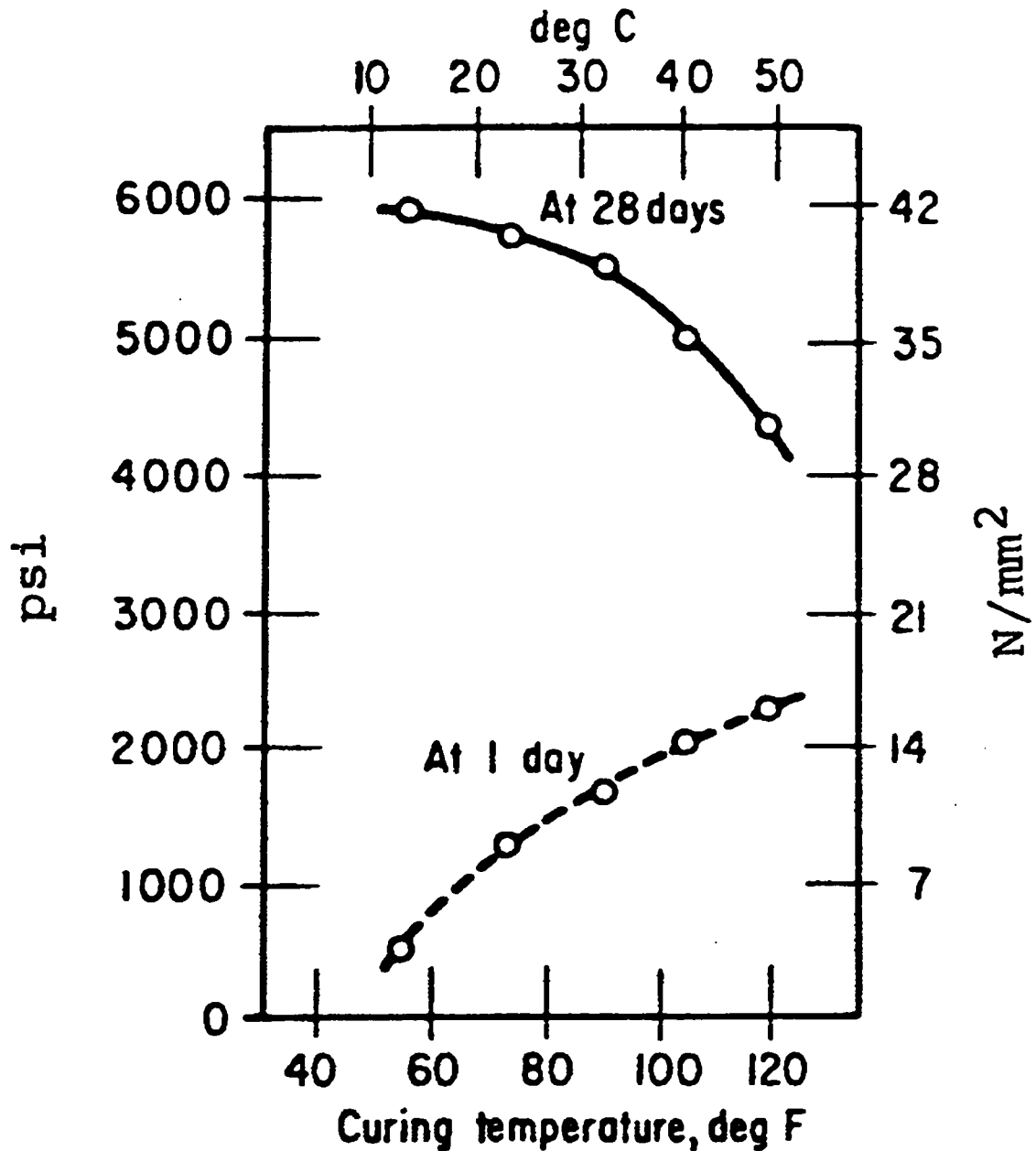

Plastic shrinkage cracking is usually associated with hot weather concreting. High concrete temperature, high air temperature, high wind velocity and low humidity, or combinations thereof, cause rapid evaporation which significantly increases the probability that plastic shrinkage cracking will occur.

As shown in Figure 10, the amount of mixing water required to make a concrete of a certain consistency, increases considerably as the temperature of fresh concrete increases.

Figure 10: Water requirement of a concrete mix increases with an increase in temperature

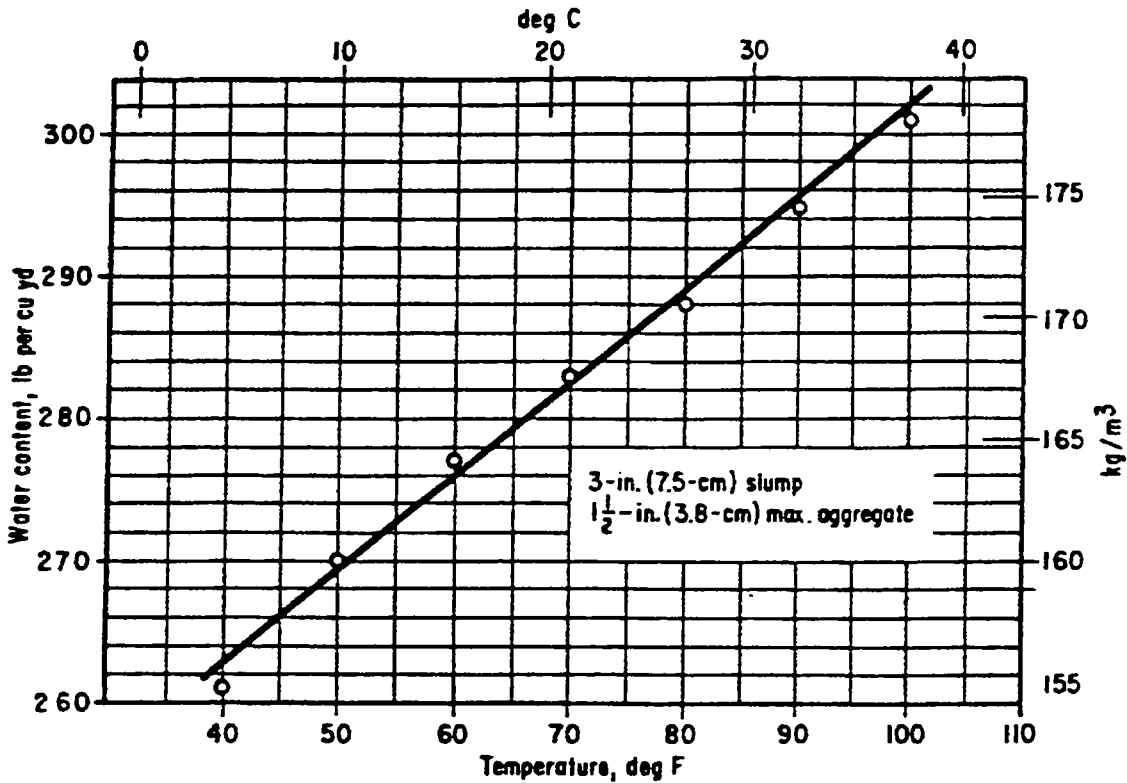

For the common, non-massive types of structure a maximum concrete temperature of 32°C is recommended by ACI as a reasonable upper limit. For the massive types of construction a temperature of 16°C or even lower would be desirable.

The most practical method of maintaining low concrete temperatures is to control the temperature of the materials.

The equation given below shows that, for concrete of conventional properties, a reduction of the concrete temperature by 1°C requires reducing either the cement temperature by about 8°C or the water temperature by about 4°C or the aggregate temperature by about 2°C.

Equation:

$$T = \frac{0.22 (T_a W_a + T_c W_c) + (T_w W_w + T_{wa} W_{wa})}{0.22(W_a + W_c) + W_w + W_{wa}}$$

- T = temperature of freshly mixed concrete (deg. C)
- T_a, T_c, T_w, T_{wa} = temperature of aggregate, cement, mixing water and water on aggregate respectively (deg. C)
- W_a, W_c, W_w, W_{wa} = weight of aggregate, cement, added mixing water and water on aggregate, respectively (kg)

Of the materials contained in concrete, water is the easiest to cool. It can be cooled by refrigeration or by adding ice which is used as part of the mixing water, provided that it is completely melted by the time mixing is completed.

Cement temperature has only a minor effect on the temperature of the freshly mixed concrete because of the low specific heat of cement and the relatively small amount of cement contained in the mix. Fresh hot cement from the plant can cause difficulties.

Aggregates have a pronounced effect on the fresh concrete temperature because they represent 60 to 80% of the total weight of concrete. Aggregate stockpiles should be shaded from the sun and kept moist by sprinkling. Before concrete is placed, the forms, the reinforcing steel, and the subgrade should be cooled by sprinkling as well.

Transporting and placing of concrete should be done as quickly as practicable. During extremely hot periods improved results may be obtained by restricting the placing of concrete to the early morning or evening hours.

In order to prevent concrete from drying out, curing should be started as soon as the concrete surface is finished. In special cases of concreting during hot weather a retarding admixture may be used to delay the setting time.

8. COLD WEATHER CONCRETING

Concreting in cold weather requires special precautions. Concrete sets slowly in cold weather and development of strength is delayed. At low temperatures (at +5°C or lower during placing and the early curing period), one or more of these recognized protective measures should be used:

- ◆ Heating the area where concrete is placed
 - The presence of ice and the possibility of ice formation during concreting must be avoided. Temperature of the concrete forms should be raised to above freezing, as well as that of adjacent concrete and subgrade, through the use of heated enclosures.
- ◆ Heating the water and concrete materials
 - In cold weather, freshly placed concrete should be at least 10°C and not more than 32°C when poured in the forms. In addition to heating water, it may be necessary to heat aggregates.
- ◆ Use of chemical accelerators
 - During low temperatures, the use of chemical accelerators can speed up the set of concrete. Calcium chloride is the most commonly used and may be used up to 2% by weight of cement.
- ◆ Calcium chloride or admixtures containing soluble chlorides must not be used:
 - in reinforced and prestressed concrete
 - in concrete containing embedded aluminium
 - in lightweight insulating concrete placed over metal decks
 - in concrete that will be in contact with soils, or water containing sulfates
- ◆ Maintaining concrete temperatures
 - Concrete slabs lose heat and moisture rapidly in cold weather. They need protection against wind and cold. A heated enclosure or insulation should be provided to keep concrete temperature above 10°C. The following Time-Temperature Chart shows minimum periods in which concrete temperatures should be maintained:

	20°C	10°C
plain concrete	3 days	7 days
plain concrete with calcium chloride	2 day	3 days

- Note: After the periods shown above, concrete temperature should be maintained above 5°C for at least four days. Concrete should not be allowed to dry out.

◆ Special provisions for curing

- Cold weather air acts like a sponge to draw moisture from concrete in both its fresh and hardened state. This rapid drying-out process must be avoided. Curing and protection from start to finish should be continuous and uninterrupted until the concrete attains its designed strength. At the end of the curing period (see Time-Temperature Chart above), protection should be removed in such a way that the temperature of the concrete will not drop faster than 5°C in 24 hours.

The following figure 11 illustrates the precautions that should be taken for cold weather concreting.

Figure 11:

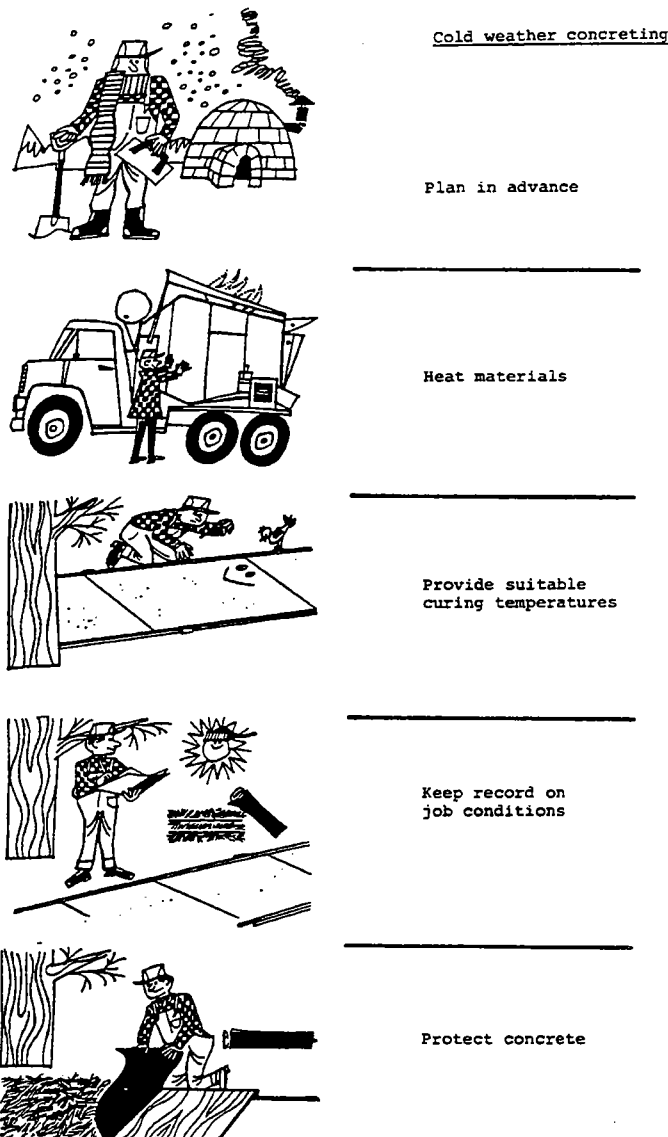

9. READY-MIXED CONCRETE

If, instead of being batched and mixed on the job site, concrete is delivered ready for placing from a central plant, it is referred to as **ready-mixed concrete**.

This type of concrete is used extensively in many countries as it offers numerous advantages as compared to the job-site-mixed concrete (Table 3).

Table 3: Production of ready-mixed concrete in W. Europe (from ERMCO Annual Report 1976/77 and 1995/96)

Country	Cement consumption in ready-mixed concrete in % of total cement consumption		Ready-mixed concrete production in mio m ³	
	1976/77	1995/96	1976/77	1995/96
Austria	19.5	44.0	4.3	8.6
Belgium	30.9	39.0	6.34	9.1
W. Germany	44.6	55.0	49.8	68.3
Finland	57.7	40.0	3.4	1.6
France	26.3	40.6	25.2	29.7
Great Britain	42.1	50.0	24.8	22.3
Italy	23.1	43.8	31.7	54.0
Spain	19.0	36.6	15.6	36.2
Holland	36.4	52.0	6.8	8.0
Sweden	48.4	61.7	5.2	2.4
Switzerland	40.7	57.0	5.6	9.0
USA	60.0	71.5	130.0	192.0

Ready-mix concrete plants use precision scales to weigh the ingredients as the producer is responsible for delivering concrete of the required quality.

There are three types of mixing:

- ◆ Transit mixed concrete is mixed completely in a truck mixer. The batching of ingredients is carried out in a dry-batch plant.
- ◆ Central mixed concrete is batched and mixed completely in a stationary batching and mixing plant (premix-plant) and is delivered in a special dump truck (tipper) without mixing or agitating, or in a truck mixer at agitating speed.
- ◆ Shrink-mixed concrete is mixed partially in a stationary mixer and then completed in a truck mixer.

Because of the many advantages offered by ready-mixed concrete, this industry has shown a phenomenal growth in recent years. These advantages can be summarized as follows:

- ◆ Use of modern precision batching equipment assures an accurately proportioned mix and allows the use and modification of different mix designs.
- ◆ Thorough mixing of each batch helps to produce uniform concrete.
- ◆ More efficient operation on the job site (no space problems with respect to storage of ingredients, etc.).
- ◆ Delivery at the time required.

- ◆ Delivery in the exact quantity desired, thus eliminating waste.
- ◆ Equipment on the building site not necessary.
- ◆ Possibility to use different chemical admixtures.
- ◆ Possibility to use special concretes.
- ◆ Clear and easy base for delivery contracts; no problems with estimates of concrete cost.

The basis for the purchase of ready-mixed concrete is the concrete volume (m^3 , cubic yard) and required concrete quality. To attain the desired concrete quality, different types of concrete mixes (mix design) can be used (see also paper on "Concrete Mix Design"):

- ◆ Designed mix (performance mix): concrete is designed by the ready-mix producer and should fulfill all requirements as stated by the purchaser.
- ◆ Codified mix: mix proportions are established in a National Code and are usually suitable for a restricted range of concrete strength classes and applications (for example in CEB-Code only for mixes with strength $\leq 25 \text{ N/mm}^2$).
- ◆ Prescribed mix: the purchaser is responsible for designing the concrete mix and specifies the mix proportions and the materials to be used by the ready-mix producer.

In recent years the ready-mixed concrete industry has gained considerable influence on the development of concrete standards and specifications. Several new developments in the concrete technology have been introduced by the ready-mixed concrete industry, e.g.

- ◆ flowing concrete
- ◆ ready-mixed mortar
- ◆ developments of new accelerated testing methods, etc.

10. PUMPED CONCRETE

Pumped concrete may be defined as concrete conveyed by pressure through either a rigid pipe or flexible hose and discharged directly into the desired area.

Pressure is applied by (see Figures 12 to 14):

- ◆ Piston pumps
- ◆ Pneumatic pumps (compressed air)
- ◆ Squeeze pressure pumps

Figure 12: Schematic drawings of the various pump types - piston type concrete pump

Piston type concrete pump

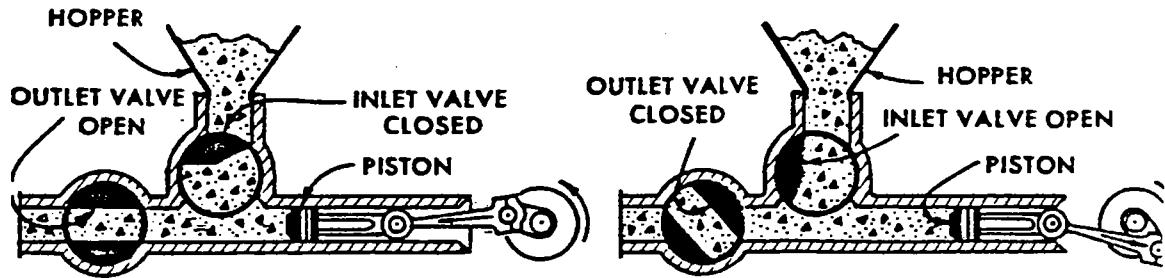

Inlet valve opens while outlet valve is closed and concrete is drawn into cylinder by gravity and piston suction. As piston moves forward inlet valve closes, outlet valve opens, and concrete is pushed into pump line.

Figure 13: Pneumatic type concrete pump

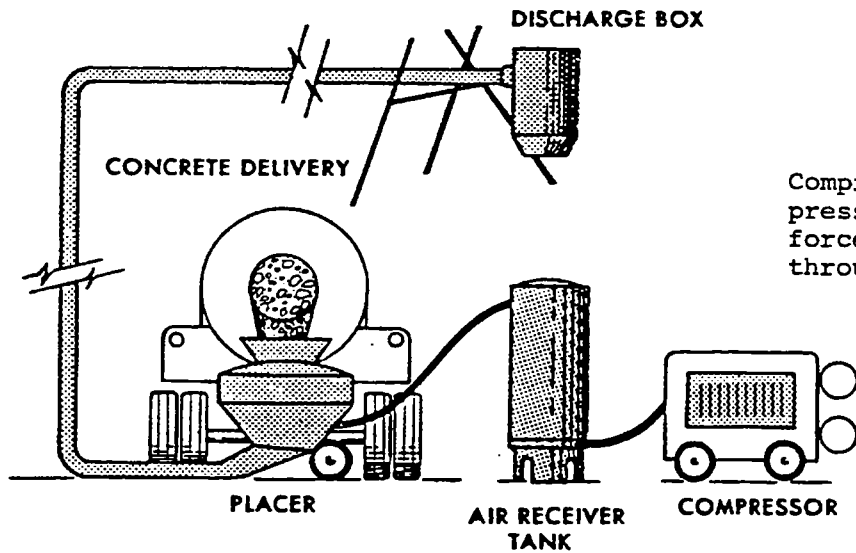

Compressor builds up air pressure in tank, which forces concrete in plunger through the line.

Compressor builds up air pressure in tank, which forces concrete in plunger through the line.

Figure 14: Squeeze Pressure Type Concrete Pump

Vacuum maintained in pumping chamber returns tube to normal shape aiding in continuous flow of concrete.

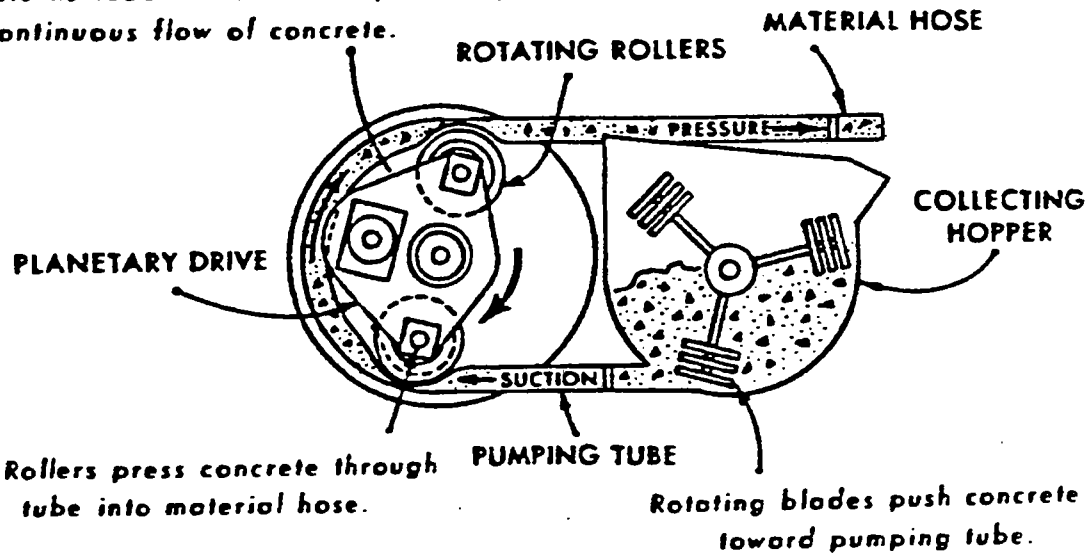

Pumping may be used for most concrete constructions, but it is especially useful where space for construction equipment is limited.

Very often the ready-mixed concrete companies include a pumping division. The portion of pumped concrete as compared to the total ready-mixed concrete production in various countries is shown in Table 4.

Table 4: Pumped concrete in proportion to the total ready-mixed concrete production (1996)

(Ready-mix concrete companies affiliated with the 'Holderbank' Group)

Country	No. of Plants	Pumped concrete in % of the total production
Belgium	55	30
France	116	7
Switzerland	18	15
W. Germany	38	49
Greece	3	74
Colombia	29	37
Costa Rica	13	33
Mexico	62	32
Brazil	40	30
Ecuador	7	70
South Africa	38	16

The concrete pumps can be:

- ◆ Truck-mounted or
- ◆ Stationary

Ease of operation, safety and economy is required of a good pump. Today the most widely used diameter of a pipe for pumping is 125 mm; the usual maximum grain size is 32 mm, the minimum cement content about 300 kg and the consistency should be plastic (slump 7 to 12 cm).

Pumping jobs over heights of more than 200 m and with volumes of up to 110 m³/hour are quite common in today's concrete practice.

11. SPECIAL CONCRETING PROCESSES

The various special concreting processes will not be discussed in detail. However, some of them are briefly explained in the following:

- ◆ Vacuum-processed concrete: concrete from which, after compaction and before hardening, water is extracted by a vacuum process. The w/c ratio is thus reduced so that concrete with higher strength, higher density, lower permeability and better durability can be obtained.
- ◆ Preplaced-aggregate concrete: concrete produced by placing coarse aggregate into a mould and later injecting a cement-sand grout, usually with admixtures to fill the voids.
- ◆ Dry-packed concrete: concrete mixture sufficiently dry to be consolidated by heavy ramming.
- ◆ Spun concrete: concrete compacted by centrifugal action, e.g. in the manufacture of pipes (centrifugal process, roller-suspension process).
- ◆ Tremie concrete: concrete placed under water through a pipe or tube.
- ◆ Shotcrete: mortar or concrete conveyed through a hose and projected at high velocity onto a surface; also known as air-blown mortar, pneumatically applied mortar or concrete, sprayed mortar and gunned concrete (gunite).

12. LITERATURE

12.1 Concrete Technology

- 1) A.M. Neville - Properties of Concrete, 4th Edition - Longman Group Ltd.
- 2) Lea's Chemistry of Cement and Concrete, 4th Edition - Arnold Ed.
- 3) Ghosh - Cement and Concrete Science and Technology - abi Books Private Ltd.

12.2 Concrete practice

- 1) W.H. Taylor - Concrete Technology and Practice
- 2) Ramachandran - Concrete Admixtures Handbook - Noyes Publications
- 3) ACI Manual of Concrete Practice - aci Publications
- 4) Properties of Fresh Concrete, Proceedings of the Rilem Colloquium - Chapman & Hall

12.3 Testing of Concrete

- 1) Bartos - Fresh Concrete, Properties and Tests - Elsevier Ed.
- 2) Concrete Test Methods.
RILEM, Secrétariat Général, 12 rue Brancion, 75737 Paris CEDEX 15

